

(19) World Intellectual Property Organization  
International Bureau



(43) International Publication Date  
18 November 2004 (18.11.2004)

PCT

(10) International Publication Number  
WO 2004/100155 A1

(51) International Patent Classification<sup>7</sup>: G11B 20/10

(81) Designated States (unless otherwise indicated, for every kind of national protection available): AE, AG, AL, AM, AT, AU, AZ, BA, BB, BG, BR, BW, BY, BZ, CA, CH, CN, CO, CR, CU, CZ, DE, DK, DM, DZ, EC, EE, EG, ES, FI, GB, GD, GE, GH, GM, HR, HU, ID, IL, IN, IS, JP, KE, KG, KP, KR, KZ, LC, LK, LR, LS, LT, LU, LV, MA, MD, MG, MK, MN, MW, MX, MZ, NA, NI, NO, NZ, OM, PG, PH, PL, PT, RO, RU, SC, SD, SE, SG, SK, SL, SY, TJ, TM, TN, TR, TT, TZ, UA, UG, US, UZ, VC, VN, YU, ZA, ZM, ZW.

(21) International Application Number:  
PCT/KR2004/001057

(22) International Filing Date: 7 May 2004 (07.05.2004)

(25) Filing Language: English

(26) Publication Language: English

(30) Priority Data:  
60/469,006 9 May 2003 (09.05.2003) US  
10-2003-0033008 23 May 2003 (23.05.2003) KR

(84) Designated States (unless otherwise indicated, for every kind of regional protection available): ARIPO (BW, GH, GM, KE, LS, MW, MZ, NA, SD, SL, SZ, TZ, UG, ZM, ZW), Eurasian (AM, AZ, BY, KG, KZ, MD, RU, TJ, TM), European (AT, BE, BG, CH, CY, CZ, DE, DK, EE, ES, FI, FR, GB, GR, HU, IE, IT, LU, MC, NL, PL, PT, RO, SE, SI, SK, TR), OAPI (BF, BJ, CF, CG, CI, CM, GA, GN, GQ, GW, ML, MR, NE, SN, TD, TG).

(71) Applicant (for all designated States except US): LG ELECTRONICS INC. [KR/KR]; 20, Yoido-dong, Youngdungpo-gu, Seoul 150-721 (KR).

(72) Inventor; and

(75) Inventor/Applicant (for US only): PARK, Yong Cheol [KR/KR]; 215-204, Jugong APT., Wonmun-dong, Gwachon-si, Gyonggi-do 427-740 (KR).

(74) Agents: BAHNG, Hae Cheol et al.; Kims International Patent & Law Office, 15th Floor Yo-Sam Building., 648-23, Yeoksam-dong, Kangnam-gu, Seoul 135-080 (KR).

Published:

- with international search report
- before the expiration of the time limit for amending the claims and to be republished in the event of receipt of amendments

For two-letter codes and other abbreviations, refer to the "Guidance Notes on Codes and Abbreviations" appearing at the beginning of each regular issue of the PCT Gazette.

(54) Title: RECORDING MEDIUM HAVING DATA STRUCTURE FOR MANAGING AT LEAST A DATA AREA OF THE RECORDING MEDIUM AND RECORDING AND REPRODUCING METHODS AND APPARATUS

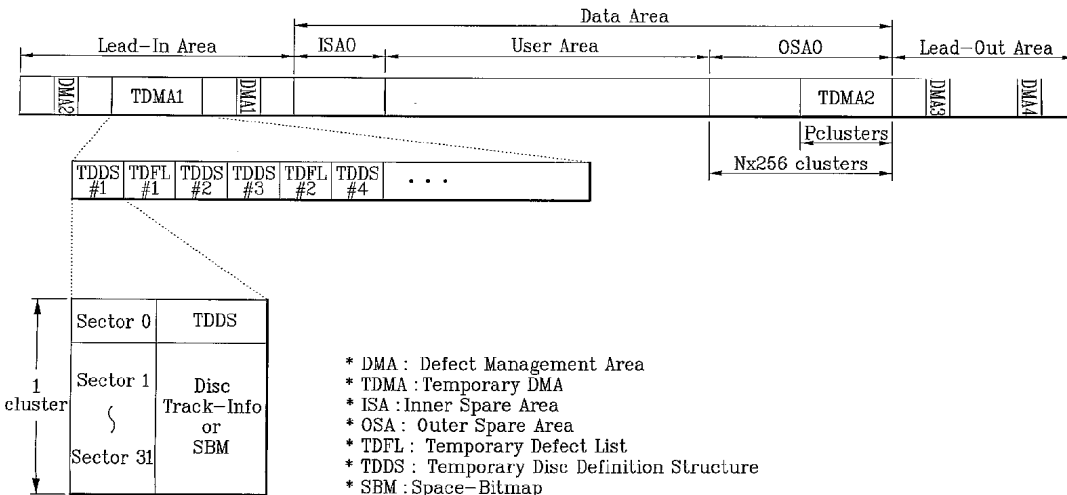

(57) Abstract: The data structure on the recording medium includes a temporary defect management area storing a data block. The data block includes a temporary definition structure. The temporary definition structure indicates a recording mode of the recording medium.

WO 2004/100155 A1

**RECORDING MEDIUM HAVING DATA STRUCTURE FOR  
MANAGING AT LEAST A DATA AREA OF THE RECORDING  
MEDIUM AND RECORDING AND REPRODUCING METHODS  
AND APPARATUSES**

5

**Technical Field**

The present invention relates to a recording medium having a data structure for managing at least a data area of the recording medium as well as methods and apparatuses for reproduction and recording.

10

## Background Art

The standardization of new high-density read only and rewritable optical disks capable of recording large amounts of data has been progressing rapidly and new optical disk related products are expected to be commercially available in the near future. For example, the blu-ray disc (BD), which belongs to the next-generation HD-DVD technology, is the next-generation optical recording solution that can strikingly surpass the data recording capability of existing DVDs.

Recording on and reading from a BD uses a celadon laser having a wavelength of 405nm, which is much denser than a red laser having a wavelength of 650nm used with existing DVDs. Thus, a greater amount of data may be stored on BD than on existing DVDs.

While at least one standard related to the BD (Blu-ray Disc) has been developed, such as BD-RE (BD Rewritable disc), many other standards such as BD-WO (BD Write

Once disc) are still in development. Standards such as BD-RE provide a data structure for managing defects in the data area of the recording medium. However, the BD-WO, because of its write-once nature, presents challenges not faced by existing BD standards such as BD-RE, and an effective data structure and method of managing  
5 defects is still under development for the BD-WO standard.

### Disclosure of Invention

The recording medium according to the present invention includes a data structure for managing at least a data area of the recording medium.

10 In one exemplary embodiment, a temporary defect management area of the recording medium stores a data block. The data block includes a temporary definition structure, and the temporary definition structure indicates a recording mode of the recording medium. For example, the recording mode may be one of sequential recording and random recording.

15 The data block may also include use status information for a data area of the recording medium. The use status information provides information on use of the data area to store data. When the recording mode is sequential recording, the data block includes sequential recording information providing information on continuous recording areas in a data area of the recording medium. When the recording mode is random  
20 recording, the data block includes a space bit map indicating recordation status of a data area of the recording medium.

Another example embodiment of the present invention provides a method of formatting a write-once recording medium. In this method, input related to a desired

recording mode for the recording medium is received, and an indicator of the desired recording mode is recorded in a temporary definition structure in a temporary defect management area of the recording medium. For example, the desired recording mode may be one of a sequential recording mode and a random recording mode. The method may further include recording sequential recording information in the temporary defect management area when the recorded recording mode indicator indicates a sequential recording mode. The sequential recording information providing information on continuous recording areas in a data area of the recording medium. The method may also further includes recording a space bit map in the temporary defect management area when the recorded recording mode indicator indicates a random recording mode. The space bit map provides information on a recordation status of a data area of the recording medium, when the recorded recording mode indicator indicates a random recording mode.

A further example embodiment of the present invention provides a method of recording management information on a write-once recording medium. In this embodiment, a recording mode indicator is reproduced from a temporary definition structure in a temporary defect management area of the recording medium, and a recording mode of the recording medium is judged based on the recording mode indicator. Then, use status information for the recording medium is recorded in the temporary defect management area based on the judging step. The use status information provides information on use of a data area of the recording medium to store data.

A still further example embodiment of the present invention provides a method of recording management information on a write-once recording medium. In this

embodiment, use status information is updated by recording updated use status information in a temporary defect management area of the recording medium when an event occurs. The use status information provides information on use of a data area of the recording medium to store data.

- 5 In another example embodiment of the present invention, a temporary defect management area of the recording medium stores a plurality of different sized defect lists. Each defect list indicates defects in a data area of recording layers of the recording medium at a time when the defect list was recorded. The temporary defect management area also stores a plurality of fixed sized temporary definition structures.
- 10 Each temporary definition structure provides use status information on a data area of one layer of the recording medium at a time when the temporary definition structure was recorded.

A further example embodiment of the present invention provides a method of recording management information on a write-once recording medium. In this

15 embodiment at least one defect list is recorded in a temporary defect management area. The defect list lists defects in data areas of recording layers of the recording medium. The recorded defect list includes new defects as compared to a previously recorded defect list such that the recorded defect list and previously recorded defect list have different sizes. This embodiment further includes recording at least one temporary

20 definition structure in the temporary defect management area. Each temporary definition structure provides use status information on a data area of one layer of the recording medium at a time when the temporary definition structure was recorded. The recorded temporary definition structure consumes a same amount of space on the recording medium as a previously recorded temporary definition structure.

A still further example embodiment of the present invention provides a method of recording management information on a write-once recording medium having a temporary defect management area in which are stored at least one temporary definition structure associated with each recording layer of the recording medium.

5 Each temporary definition structure includes use status information providing information on use of a data area in the associated recording layer to store data. The method includes recording, in a defect management area of the recording medium, a most current temporary definition structure associated with each recording layer.

The present invention further provides apparatuses and methods for recording and  
10 reproducing the data structure according to the present invention.

#### Brief Description of Drawings

The above features and other advantages of the present invention will be more clearly understood from the following detailed description taken in conjunction with the  
15 accompanying drawings, in which:

Fig. 1 illustrates a single-layer write once optical disc according to an example embodiment of the present invention;

Fig. 2 illustrates a comparison of the disc management information of a conventional rewritable optical disc to the disc management information of the present invention;

20 Fig. 3 illustrates an optical disc initializing method based on recording mode according to an embodiment of the present invention;

Fig. 4 illustrates the different kinds of basic tracks of a write-once optical disc according to an example embodiment of the present invention;

Figs. 5A and 5B illustrate a data structure of the write-once optical disc, and more specifically, the temporary disc management information according to an embodiment of the present invention;

5 Fig. 6 schematically illustrates the direction in which the different areas of the optical disc are recorded;

Fig. 7A illustrates the case where the SBM (space bit map) is recorded in the 31 leading sectors in a cluster, and the TDDS (temporary disc definition structure) is recorded in the remaining sector;

Fig. 7B illustrates an example of the data structure of the SBM;

10 Figs. 8 and 9 respectively illustrate exemplary embodiments of methods for recording information in a TDMA and DMA according to the present invention; and

Fig. 10 illustrates an embodiment of a recording and reproducing apparatus according to the present invention.

## 15 Best Mode for Carrying Out the Invention

In order that the invention may be fully understood, exemplary embodiments thereof will now be described with reference to the accompanying drawings. For convenience, a write-once optical Blu-ray disc will be used as an example of a write-once recording medium in the exemplary embodiments.

20

### Data Structure of the Recording Medium

Figs. 1 and 2 illustrate a data structure of the write-once optical disc, and more specifically, temporary disc management information according to an embodiment of

the present invention. The configuration of the write-once optical disc shown in Fig. 1 is described in detail in Korea Patent Application no. 2003-15634.

As shown, the write-once optical disc in this example is a single layer disc that has one recording layer. The disc includes spare areas (ISA0/ISA1) for recording data the  
5 could not be recorded in the main data area because of defects in the main data area (e.g., physical defects). Information for managing the replacement of defective portions of the data area with portions of the spare area is recorded in a temporary defect management area or areas (TDMA).

In general, a rewritable, as opposed to a write-once, optical disc has a limited defect  
10 management area (DMA) because data can be written and erased from the DMA repeatedly. A write-once optical disc needs a larger amount of space to manage defects since data can be written only once and not erased. Accordingly, the TDMA is used for recording the defect management information as this information changes during use of the optical disc. Once the disc is complete, the last version of the defect  
15 management information is copied from the TDMA to a DMA on the write-once optical disc.

Referring to Fig. 1, the TDMA includes TDMA1 allocated to a lead-in area having a fixed size and TDMA2 allocated to spare area OSA0. The TDMA2 has a size interworking with the size of the spare area. For example, the size of the spare area  
20 OSA0 is  $N \times 256$  cluster, of which the TDMA2 forms  $P$  clusters. The number of clusters  $P$  may be determined according to the expression  $P = (N * 256) / 4$ . In each TDMA, temporary defect management information in the form of a temporary defect list (TDFL), a temporary disc definition structure (TDDS), and disc use status information may be recorded.



As discussed above, when a defect area exists in the data area, a spare area (ISA0/OSA0) is substituted for the defect area. The TDFL provides information to manage this process in the form of a list. For example, the list indicates the defect area and the spare area replacing the defect area. According to one embodiment of the present invention, the size of the TDFL, varies from 1 to 4 clusters depending on the amount of information in the TDFL. By contrast, according to one example embodiment of the present invention, the amount of space devoted to the TDDS remains fixed at one cluster. According to this embodiment, this data block includes the TDDS and disc usage status information as discussed in detail below with respect to Figs. 2, 5A-5B and 7A-7B. As will be discussed in greater detail below, the disc usage status information may be sequential recording information (e.g., track information) or a space bit map depending on a recording mode of the write-once optical disc.

Referring first to Fig. 2, the disc management information of the conventional rewritable optical disc will be compared with the contents included in the TDDS of the present invention.

In the case of a rewritable optical disk, the DDS consumes a very small portion of the disc - about 60 bytes of one cluster (one cluster having 32 sectors). The remaining area of the cluster is set by 'zero padding'. However, according to this embodiment of the present invention, the remaining area as well as the area (60 bytes) used in the conventional rewritable optical disk is used as disc management information. Accordingly, in the TDDS of the present invention, information particular to a write-once optical disc as well as DDS as used in the conventional rewritable optical disc is recorded sequentially in one sector (2048 bytes). For example, the information

particular to the write-once optical disc includes a recording mode indicator indicating a recording mode of the recording medium from a plurality of possible recording modes. The recording modes and recording mode indicator are discussed in greater detail below. The information may also include position information of the latest TDFL.

As shown in Figs. 1 and 2, disc use status information (e.g., sequential recording information such as track information or space bit map depending on the recording mode of the recording medium as discuss in detail below) is recorded on the remaining 31 sectors of one cluster that includes the TDDS. Alternatively, the disc use status information may be configured in 31 sectors in the front of TDDS and the TDDS may be configured on the last, 32nd sector. The disc use status information changes according to use by the user of the disc, and, as discussed in detail below, provides information that may be used to accurately search for an additional recordable area through discrimination of recorded/non-recorded area information.

Accordingly, the TDDS as used in this disclosure should be construed broadly as described above and not as a term defined according to one particular standard.

#### Recording Mode and Initialization Method

Fig. 3 illustrates an optical disc initializing method based on recording mode according to an embodiment of the present invention.

As described above, the present invention intends to support diverse recording methods even with respect to the optical disc write once, and the methods are a 'sequential recording mode' and a 'random recording mode'.

The 'sequential recording mode' is a recording mode which includes a DAO (Disc At Once) mode for recording at once the whole disc adopted by the related art optical disc write once standards and an incremental recording mode for sequentially recording information in continuous recording areas of the disc. In the sequential recording mode of the present invention, the number of additional recordable areas in the disc is not limited in the incremental recording mode. A continuous recording in which data is sequentially recorded will be referred to as a track in this disclosures, and the sequential recording information may be referred to as track information. This track information will be discussed in detail below.

10 The 'random recording mode' is a recording mode that enables free recording over the whole area of the disc. That is, this mode does not limit the order of recording data on the recording area of the disc. Here, a space bit map (SBM) is used as disc use status information to indicate the recordation status of the disc. This SBM will be discussed in more detail below.

15 As the present invention supports a plurality of recording modes as described above, when a write-once disc is first used, a determination of the recording mode is made, and the disc is initialized to the recording mode. That is, a user, disc manufacturer, or host (hereinafter collectively referred to as host) decides on the recording mode for the disc, and sets the recording mode in a specified management area of the disc.

20 Specifically, if the host inputs the recording mode of the disc, the disc recording system sets one byte in the TDDS to indicate the recording mode and determines the format of the disc use status information associated with the recording mode. For example, if the recording mode is a sequential recording mode, the system sets the recording mode to '0000 0000b', and sets the 'track information' as the use status

information. If the recording mode is a random recording mode, the system sets the recording mode to '0000 0001b', and sets the 'SBM' as the use status information. Accordingly, when the disc is used thereafter, the system records data on the disc according to the determined recording mode, and updates one of the corresponding use status information as the management information of the disc.

Consequently, if the initialization is completed and the disc write once is loaded, the system first judges the recording mode of the corresponding disc, determines one among the plurality of the disc use status information according to the recording mode judgment, and updates the determined use status information in the disc management area set in the corresponding disc.

Hereinafter, the detailed structure and recording method of the 'track information' and the 'SBM' managed in association with the recording mode in the TDDS will be explained, and then a method of recording the TDDS and the TDFL in the TDMA and the DMA will be explained.

15

### Kinds of Tracks

Referring to Fig. 4 the kinds of tracks and physical structure of the disc according to an example embodiment of the of the present invention will be described. A continuous recording area in which data is sequentially recorded will be referred to as a track in this disclosure. Fig. 4 illustrates the different kinds of basic tracks of a write-once optical disc according to an example embodiment of the present invention. More specifically, Fig. 4 illustrates a plurality of continuous recording areas or tracks having different status assuming use of the write-once disc over a period of time. As

shown, tracks 1 and 2 correspond to open tracks that while storing data in a first area thereof, each have a later area on which additional recording is possible. The tracks 3 and 4 correspond to complete or closed tracks that are completely filled (track 4) or are closed for further recording (track 3). As shown by track 3, when a track having  
5 an unrecorded area is closed such that no further recording in the track is permitted, the unrecorded area is padded with zeros (shown as a hatched portion in Fig. 4) and changed to be a complete track. Track 3 is different from track 4 in that point.

Track 5 provides an example of the last track that includes an area on which additional recording is possible. This track is called an intermediate track.

10 Accordingly, there are three kinds of tracks – open, closed and intermediate.

Each of the tracks has a last recorded address (LRA) regardless of the kind of the track.

The LRA is the last address at which actual data was recorded in the track.

Accordingly, with respect to track 3, the position (or address) before the track 3 was padded with zeros is the LRA for track 3 (LRA3). More specifically, assuming the  
15 unit for recording data on the optical disc is a cluster, and there are 32 sectors in one cluster, if less than the 32 sectors have data recorded therein, then the remaining sectors are padded with zeros. The last sector address before the padding is the LRA.

For each of the open and intermediate tracks, but not the closed tracks, a next writable address (NWA) indicating the next address into which data may be written may be  
20 determined. The NWA is obtained from the LRA as the next sector address following the LRA.

#### Data Structure of Track Information on the Recording Medium

First, the present invention does not limit the number of the open tracks. Accordingly, there may exist a plurality of open tracks and complete tracks. The present invention provides a data structure on the recording medium for managing this potential in an efficient manner. As shown in Fig. 5A, the recording mode indicator in the TDDS  
5 indicates the sequential recording mode and the disc use status information is track information. An embodiment of this track information data structure will now be described in detail with respect to Fig. 5B.

As shown, the sequential recording, or more particularly, the track information includes three parts: a header for indicating that the data structure provides track  
10 information, a track information list providing the track information, and an terminator indicating an end of the track information.

The header is positioned at the front portion of the track information and includes a 'track information structure identifier' field indicating that information following the identifier is track information. The next indicator 'track information format' indicates  
15 the format of the track information. This is followed by a 'layer number (0 or 1)' field representing the recording layer to which the track information corresponds. While the example thus far has been for a single sided, single recording layer write-once optical disc, the optical disc may have multiple recording layers and/or be double sided.

20 The header further includes a 'total number of tracks' field representing the number tracks in the data area of the recording layer to which the track information corresponds, and 'total number of open tracks' field representing the number of the open tracks in this data area. Before reading the track information list, the total track information may be confirmed.

The track information list is recorded after the header and will be described in greater detail below. The track information list terminator represents the end of the track information. Accordingly, the track information includes a header, track information list and a terminator recorded in series.

5 An example embodiment of the track information list will now be described in more detailed. The track information list includes one entry for each track in the corresponding data area of the disc. Each entry may be allocated to, for example, 8 bytes. This track information entry includes track status information, a first address of the corresponding track and the last recorded address information of the track.

10 The track status information indicates the kind of track – open, closed or intermediate, and may be represented by 4 bits as shown in Fig 3B. In this embodiment of the present invention, an open track in which additional recording is possible is indicated by ‘0000b’ as the track status information. An intermediate track is indicated by ‘0001b’ as the track status information, and a complete track, in which additional  
15 recording is not permitted, is indicated by ‘1000b’ as the track status information. The track status information is represented as specific bits as described above to aid in sorting the track information list entries as described later in this disclosure.

In the example of Fig. 5B, the first address information of an entry is a ‘start physical sector number (PSN) of track’ field. This field provides the sector address of the first  
20 sector forming the track. The last recorded address information in the example of Fig. 5B is the LRA of the track. Accordingly, if one entry is read, the kind of track, the start position and LRA of the track may be determined.

The track status information in each entry may also include a session start bit (e.g., one of the bits in the track status information in each entry may be used as the session

start bit). The session status indicates if the track is the first track or not the first track in a session. Here, the clustering of tracks into a group is called a session.

### Space Bit Map Structure and Recording Method

5 Fig. 6 schematically illustrates the direction in which the different areas of the optical disc are recorded. This explanation will be helpful in understanding the data structure of the SBM described in detail below with respect to Figs. 7A and 7B.

While Fig. 1 illustrated an example of a single layer optical disc, BD-WO may have a plurality of recording layers. As such, aspects of the single layer optical disc  
10 according to the present invention may be applied to both layers. For the purposes of explanation, Fig. 6 schematically illustrates a plurality of layers for the respective areas in an optical disc write once, such as a BD-WO.

In the BD-WO of Fig. 6, first and second recording layers Layer0 and Layer1 (hereinafter referred to as 'L0' and 'L1') may exist. The respective recording layers  
15 include an inner area, an inner spare area, a user area, an outer spare area, and an outer area. In the case of a dual-layer disc, the inner area of the first recording layer L0 becomes the lead-in area, and the inner area of the second recording layer L1 becomes the lead-out area. However, in the case of the single-layer disc, the outer area will be the read-out area.

20 Fig. 6 shows that the first recording layer L0 is used from the inner periphery to the outer periphery, and only the outer spare area OSA0 thereof is used from the outer periphery to the inner periphery. The second recording layer L1 is used from the outer periphery to the inner periphery, and only the inner spare area ISA1 thereof is used from the inner periphery to the outer periphery. Accordingly, the start position of the



respective area is determined according to a use direction of the area. However, this just corresponds to the use efficiency of the disc, and if the use direction of the respective area is changed, the start position of the area is also changed.

In a state that the use direction and the start position of the respective area of the disc  
5 are defined as described above, the method of indicating the SBM, which is changed according to the use status of the disc, will now be explained in detail.

As shown in Fig. 7A, the recording mode indicator in the TDDS indicates the random recording mode and the disc use status information is the SBM. Fig. 7B illustrates an example of the data structure of the SBM. As shown, the SBM includes three parts: a  
10 header for enabling recognition of the SBM, SBM information for directly indicating the SBM, and an SBM terminator for informing an end of the SBM.

The header, in addition to identifying this information field as an SBM, includes a recording layer information field and a format version field. The recording layer information field indicates which recording layer (e.g., layer number 0 or 1) the SBM  
15 is associated. The format version field indicates to which format version the SBM conforms.

The SBM information is prepared for each divided area of the disc as shown in Fig. 4B, and whether to update the SBM may be determined as needed by a user, a disc manufacturer or a host (hereinafter collectively referred to as a host). Specifically, the  
20 SBM information includes start position information (Start Cluster First PSN) of each area, length information of the corresponding area, and bitmap data for each area. In one example embodiment, the bitmap information is updated only once the start position information and the length information are set. This method is called an SBM on/off function, and is for actively coping with the diverse requests of the host. Also,

in the case of the BD-WO, if the use environment corresponds to a real-time recording, defect management may not be performed. In this case, the spare area is not allocated and it is not required to update the SBM of the corresponding area.

Also, in one particular case, only the user area, which is an area where the user data is recorded, may be managed by the SBM, and the SBM will not be updated for changes to the other areas. Operating according to this embodiment is beneficial because if the SBM is updated whenever the management information is changed, frequent updates to the SBM may be required. This embodiment may prevent quickly using up the available TDMA area on the disc. Accordingly, if it is desired to perform the SBM updating of the user data area only using the SBM on/off function and not to update the remaining area, the start position information and the length information of the other areas are set to a specified value, for example, to a 'zero' value.

As will be appreciated, with each update of the SBM, a new SBM+TDDS data block is recorded in the TDMA, where the SBM provides a cumulative indication of the recordation status of the disc. As such, with each updating of the SBM, the TDDS is updated; particularly, to indicate the new position of the SBM.

#### Track Information Update Method

When to update the disc use status information may be a design parameter established according to the system or system designer. However, examples of events triggering update will be described in detail below.

When a new track is generated or a track is closed in the sequential recording mode, since the track information is newly generated, the track information may be updated. Similarly, when a new recordable area is changed during random recording, the SBM

is updated. When a disc is ejected from a driver or the power to the driver is turned off, use of the disc is stopped at least temporarily. At these times, the track information is updated.

## 5 TDMA and DMA Recording Method

Figs. 8 and 9 respectively illustrate exemplary embodiments of methods for recording information in a TDMA and DMA according to the present invention. FIG. 8 illustrates the method of recording the TDDS information, the disc use status information and the TDFL in the TDMA during the use of the disc, and Fig. 9  
10 illustrates the method of transferring the final or most current version of the information recorded in TDMA to DMA if the disc is finalized.

Fig. 8 illustrates only the case of TDMA1, which exists in the lead-in area. However, it will be apparent that this method may also be performed in a TDMA that exists in another area of the disc. According to the present invention, the TDFL and the TDDS  
15 are recorded in the TDMA through the following method.

The TDFL is recorded and managed in the order of generation of the defect area irrespective of the recording layer, and has a variable size. That is, as the recording goes over cluster 1 due to an increase in defect areas, the TDFL may grow in size from one to eight clusters. The number of clusters is obtained considering the whole disc  
20 capacity when a multi-layer BD-WO is applied (e.g., 4 clusters for a single recording layer disc and 8 clusters for a dual recording layer disc).

Next, the TDDS having a fixed size, is dividedly recorded and managed for the multiple recording layers. Namely, a TDDS for each recording layer is recorded alternately after the TDFL as shown in Fig. 8. This corresponds to the fact that the

'track information' and the 'SBM', which are recorded with the TDDS, are dividedly recorded in the respective recording layers. Also, in the TDDS, an area is allocated so as to record therein 'position information (of 4bytes) of the newest TDFL' and the 'newest TDDS position information (of 4bytes) of other recording layers. Whenever  
5 the TDDS is updated, the above information is updated. Thus, by reading the TDDS information (irrespective of the recording layer) recorded last, all information on the corresponding disc, for example, the disc recording mode, newest use status information (track information or SBM), newest TDFL position information, newest TDDS position information of other recording layers may be confirmed to achieve an  
10 efficient management of the disc.

Fig. 9 illustrates the recording of data for only the case of DMA1 and DMA2, which exist in the lead-in area. However, it will be apparent that the recording method may also be performed in DMAs, which exist in another area of the disc.

First, the recording in the DMA may be performed when further recording is  
15 impossible (which may be occur when the TDMA or the spare area becomes full) or when the user, optionally, finalizes the disc. The contents recorded in the DMA are the final TDDS(with disc use status information)/TDFL information in the TDMA. This information is transferred as the DDS/DFL information of the DMA. Accordingly, the TDDS/TDFL information is recorded in the DDS/DFL as it is without any change of  
20 the recorded contents. The DDS/DFL means the final record of the disc in the DMA, and has the same structure and contents as the TDDS/TDFL.

According to the present invention, the DDS and the DFL are recorded through the following method.

The DMA according to one example embodiment of the present invention includes 64 clusters in the case of the multiple recording layers. The 8 leading clusters provide an area for recording the DDS information, and the 54 remaining clusters provide an area for recording the DFL information.

5 The DDS in the DMA has the same structure as the TDDS. In the upper sector 1 of the cluster 1 of the DDS, an area for recording the same information as that used in the BD-RE, and an area for recording information used only in the BD-WO (for example, disc recording mode, newest use status information (track information or SBM), newest TDFL position information, newest TDDS position information of other  
10 recording layers, etc.) is provided. In the 31 remaining sectors, the 'track information' or 'SBM' determined in association with the recording mode as the disc use status information are dividedly recorded in the respective recording layers.

Also, a sequential recording is performed in the order of the TDDS of the first recording layer (TDDS for L0) and the TDDS of the second recording layer (TDDS  
15 for L1), and then a repeated recording is performed in the order of the TDDS of the second recording layer (TDDS for L1) and the TDDS of the first recording layer (TDDS for L0). This recording method account for the actual structure of the disc and prepares against the possibility of damaging the DMA information due to the direction (mainly, horizontal direction) of a scratch on the disc.

20 Also, since the DFL in the DMA has the same contents as the final TDFL and the TDFL is recorded using 8 clusters at maximum, the repeated recording thereof can be performed as many times as required by a system. At this time, the number of times of repetition is 7 at maximum.

As described above, the method of recording management information on an optical disc write once according to the present invention enables a selective recording of the disc use status information ('track information' and 'SBM') according to the determined recording mode, and enables an efficient recoding of the information in TDMA and DMA, and thus an efficient and progressive disc use can be achieved.

Fig. 10 illustrates a schematic diagram of an embodiment of an optical disk recording and reproducing apparatus according to the present invention. As shown, an encoder 9 receives and encodes data (e.g., still image data, audio data, video data, etc.). The encoder 9 outputs the encoded data along with coding information and stream attribute information. A multiplexer 8 multiplexes the encoded data based on the coding information and stream attribute information to create, for example, an MPEG-2 transport stream. A source packetizer 7 packetizes the transport packets from the multiplexer 8 into source packets in accordance with the audio/video format of the optical disk. As shown in Fig. 10, the operations of the encoder 9, the multiplexer 8 and the source packetizer 7 are controlled by a controller 10. The controller 10 receives user input on the recording operation, and provides control information to encoder 9, multiplexer 8 and the source packetizer 7. For example, the controller 10 instructs the encoder 9 on the type of encoding to perform, instructs the multiplexer 8 on the transport stream to create, and instructs the source packetizer 7 on the source packet format. The controller 10 further controls a drive 3 to record the output from the source packetizer 7 on the optical disk.

The controller 10 also creates the navigation and management information for managing reproduction of the data being recorded on the optical disk. For example, the controller 10 controls the drive 3 to record one or more of the data structures of

Figs. 1-9 on the optical disk and perform the recording and reproducing methods described above.

During reproduction or further recording operations, the controller 10 may control the drive 3 to reproduce this data structure. Based on the information contained therein, as well as user input received over the user interface (e.g., control buttons on the recording and reproducing apparatus or a remote associated with the apparatus), the controller 10 controls the drive 3 to reproduce and/or record data from/to the optical disk as discussed in detail above.

Reproduced source packets are received by a source depacketizer 4 and converted into a data stream (e.g., an MPEG-2 transport packet stream). A demultiplexer 5 demultiplexes the data stream into encoded data. A decoder 6 decodes the encoded data to produce the original data that was fed to the encoder 9. During reproduction, the controller 10 controls the operation of the source depacketizer 4, demultiplexer 5 and decoder 6. The controller 10 receives user input on the reproducing operation, and provides control information to decoder 6, demultiplexer 5 and the source packetizer 4. For example, the controller 10 instructs the decoder 9 on the type of decoding to perform, instructs the demultiplexer 5 on the transport stream to demultiplex, and instructs the source depacketizer 4 on the source packet format.

While Fig. 10 has been described as a recording and reproducing apparatus, it will be understood that only a recording or only a reproducing apparatus may be provided using those portions of Fig. 10 providing the recording or reproducing function.

The write-once optical disc management data structure and method of recording and reproducing this data structure as well as updating the management data provide information regarding the use of the recording medium to store data.

**Industrial Applicability**

The data structure for and method for managing at least a data area of a high-density recording medium in accordance with embodiments of the present invention enables  
5 an efficient and progressive use of a write-once recording medium such as BD-WO.

As apparent from the above description, the present invention also provides apparatuses for recording a data structure on a high density recording medium for managing at least a data area of the recording medium.

While the invention has been disclosed with respect to a limited number of  
10 embodiments, those skilled in the art, having the benefit of this disclosure, will appreciate numerous modifications and variations there from. For example, while described with respect to a Blu-ray Write-Once optical disk in several instances, the present invention is not limited to this standard of optical disk or to optical disks. It is intended that all such modifications and variations fall within the spirit and scope of  
15 the invention.



## Claims

1. A write-once recording medium having a data structure for managing a data area of the recording medium, comprising:

5           a temporary defect management area storing a data block, the data block including a temporary definition structure, the temporary definition structure indicating a recording mode of the recording medium.

2. The recording medium of claim 1, wherein the data block further includes use  
10 status information for a data area of the recording medium, the use status information providing information on use of the data area to store data.

3. The recording medium of claim 1, wherein the recording mode is one of sequential recording and random recording.

15

4. The recording medium of claim 3, wherein when the recording mode is sequential recording, the data block includes sequential recording information providing information on continuous recording areas in a data area of the recording medium.

20 5. The recording medium of claim 4, wherein the sequential recording information includes a header, information entries for each continuous recording area and a terminator, the header identifying the sequential recording information as sequential recording information, each information entry providing information on an associated

continuous recording area, and the terminator indicating an end of the sequential recording information.

6. The recording medium of claim 5, wherein the header information indicates a  
5 number of the continuous recording areas.

7. The recording medium of claim 6, wherein the header information indicates a number of the continuous recording areas open for recording.

10 8. The recording medium of claim 5, wherein the header information indicates a number of the continuous recording areas open for recording.

9. The recording medium of claim 5, wherein each information entry indicates whether the associated continuous recording area is a first continuous recording area  
15 in a group of continuous recording areas.

10. The recording medium of claim 5, wherein each information entry indicates whether the associated continuous recording area is open for recording.

20 11. The recording medium of claim 5, wherein each information entry indicates a starting physical sector number of the associated continuous recording area.

12. The recording medium of claim 5, wherein each information entry indicates a last recording address of the associated continuous recording area.

13. The recording medium of claim 5, wherein each information entry indicates a status of the associate continuous recording area, indicates a starting physical sector number of the associated continuous recording area, and indicates a last recording address of the associated continuous recording area.

5

14. The recording medium of claim 13, wherein the status indicates whether the associated continuous recording area is a start of a group of continuous recording areas.

10

15. The recording medium of claim 3, wherein when the recording mode is random recording, the data block includes a space bit map indicating recordation status of a data area of the recording medium.

15

16. The recording medium of claim 15, wherein the space bit map includes space bit map data, a data pointer pointing to the space bit map data, and a length indicator indicating a length of the space bit map data.

17. The recording medium of claim 16, wherein the data pointer indicates a first physical sector number of the space bit map data.

20

18. The recording medium of claim 16, wherein the space bit map data includes a status indicator associated with each recording unit of the data area, the status indicator indicating whether data is recorded in the associated recording unit.
- 5 19. The recording medium of claim 18, wherein the recording unit is a cluster.
20. The recording medium of claim 16, wherein the space bit map further includes a format indicator indicating a format of the space bit map.
- 10 21. The recording medium of claim 16, wherein
- the recording medium is a dual layer optical disc; and
- the space bit map further includes a layer indicator indicating a layer to which the space bit map corresponds.
- 15 22. A method of formatting a write-once recording medium, comprising:
- receiving input related to a desired recording mode for the recording medium;
- and
- recording an indicator of the desired recording mode in a temporary definition structure in a temporary defect management area of the recording medium.
- 20 23. The recording medium of claim 22, wherein the desired recording mode is one of

a sequential recording mode and a random recording mode.

24. The method of claim 23, further comprising:

5 recording sequential recording information in the temporary defect management area, the sequential recording information providing information on continuous recording areas in a data area of the recording medium when the recorded recording mode indicator indicates a sequential recording mode.

25. The method of claim 23, further comprising:

10 recording a space bit map in the temporary defect management area, the space bit map provides information on a recordation status of a data area of the recording medium when the recorded recording mode indicator indicates a random recording mode.

15 26. A method of recording management information on a write-once recording medium, comprising:

reproducing a recording mode indicator from a temporary definition structure in a temporary defect management area of the recording medium;

judging a recording mode of the recording medium based on the recording mode indicator; and

20

recording use status information for the recording medium in the temporary defect management area based on the judging step, the use status information providing information on use of a data area of the recording medium to store data.

27. The method of claim 26, wherein the use status information is sequential recording information that provides information on continuous recording areas in the data area of the recording medium when the judging step judges that the reproduced recording mode indicator indicates a sequential recording mode.

5

28. The method of claim 26, wherein the use status information is a space bit map that provides information on a recordation status of the data area when the judging step judges that the reproduced recording mode indicator indicates a random recording mode.

10

29. A method of recording management information on a write-once recording medium, comprising:

updating use status information by recording updated use status information in a temporary defect management area of the recording medium when an event occurs, the use status information providing information on use of a data area of the recording medium to store data.

15

30. The method of claim 29, further comprising:

reproducing a recording mode indicator from the temporary defect management area, the recording mode indicator indicating a recording mode of the recording medium; and wherein

20

the updating step updates the use status information according to a format associated with the recording mode indicated by the recording mode indicator.

31. The method of claim 29, wherein the event is creation of a new recording area in the data area.

32. The method of claim 29, wherein the event is a recording area in the data area  
5 having been changed to a recording completed area.

33. The method of claim 29, wherein the event is one of the recording medium being  
ejected from a recording medium driver and powering off of the recording medium  
driver driving the recording medium.

10

34. The method of claim 29, wherein the use status information is one of sequential  
recording that provides information on continuous recording areas in the data area of  
the recording medium and a space bit map that provides information on a recordation  
status of the data area.

15

35. A write-once recording medium having a data structure for managing a data area  
of a recording medium, comprising:

a temporary defect management area storing a plurality of different sized  
defect lists, each defect list indicating defects in a data area of recording layers of the  
recording medium at a time when the defect list was recorded, and the temporary  
20 defect management area storing a plurality of fixed sized temporary definition  
structures, each temporary definition structure providing use status information on a  
data area of one layer of the recording medium at a time when the temporary  
definition structure was recorded.

36. A method of recording management information on a write-once recording medium, comprising:

recording at least one defect list in a temporary defect management area, the defect list listing defects in data areas of recording layers of the recording medium, the  
5 recorded defect list including new defects as compared to a previously recorded defect list such that the recorded defect list and previously recorded defect list have different sizes; and

recording at least one temporary definition structure in the temporary defect management area, each temporary definition structure providing use status  
10 information on a data area of one layer of the recording medium at a time when the temporary definition structure was recorded, the recorded temporary definition structure consuming a same amount of space on the recording medium as a previously recorded temporary definition structure.

15 37. A method of recording management information on a write-once recording medium having a temporary defect management area in which are stored at least one temporary definition structure associated with each recording layer of the recording medium, each temporary definition structure including use status information providing information on use of a data area in the associated recording layer to store  
20 data, comprising:

recording, in a defect management area of the recording medium, a most current temporary definition structure associated with each recording layer.

38. The method of claim 37, wherein the recording step records the most current



temporary definition structure associated with each recording layer more than once in the defect management area.

39. The method of claim 37, wherein

5           the recording medium includes first and second recording layers; and  
            the recording step records, in sequence, the most current temporary definition structure associated with the first recording layer, the most current temporary definition structure associated with the second recording layer, the most current temporary definition structure associated with the second recording layer and the  
10          most current temporary definition structure associated with the first recording layer.

40. A method of recording management data on a write-once recording medium, comprising:

            recording a data block in a temporary defect management area, the data block  
15          including a temporary definition structure, the temporary definition structure indicating a recording mode of the recording medium.

41. A method of reproducing data from a write-once recording medium, comprising:

            reproducing at least a portion of data recorded on the recording medium based  
20          on a data block recorded in a temporary defect management area of the recording medium, the data block including a temporary definition structure, the temporary definition structure indicating a recording mode of the recording medium.

42. An apparatus for recording management data on a write-once recording medium, comprising:

5 a driver for driving an optical recording device to record data on the recording medium; and

a controller for controlling the driver to record a data block in a temporary defect management area, the data block including a temporary definition structure, the temporary definition structure indicating a recording mode of the recording medium.

10

15

20

FIG. 1

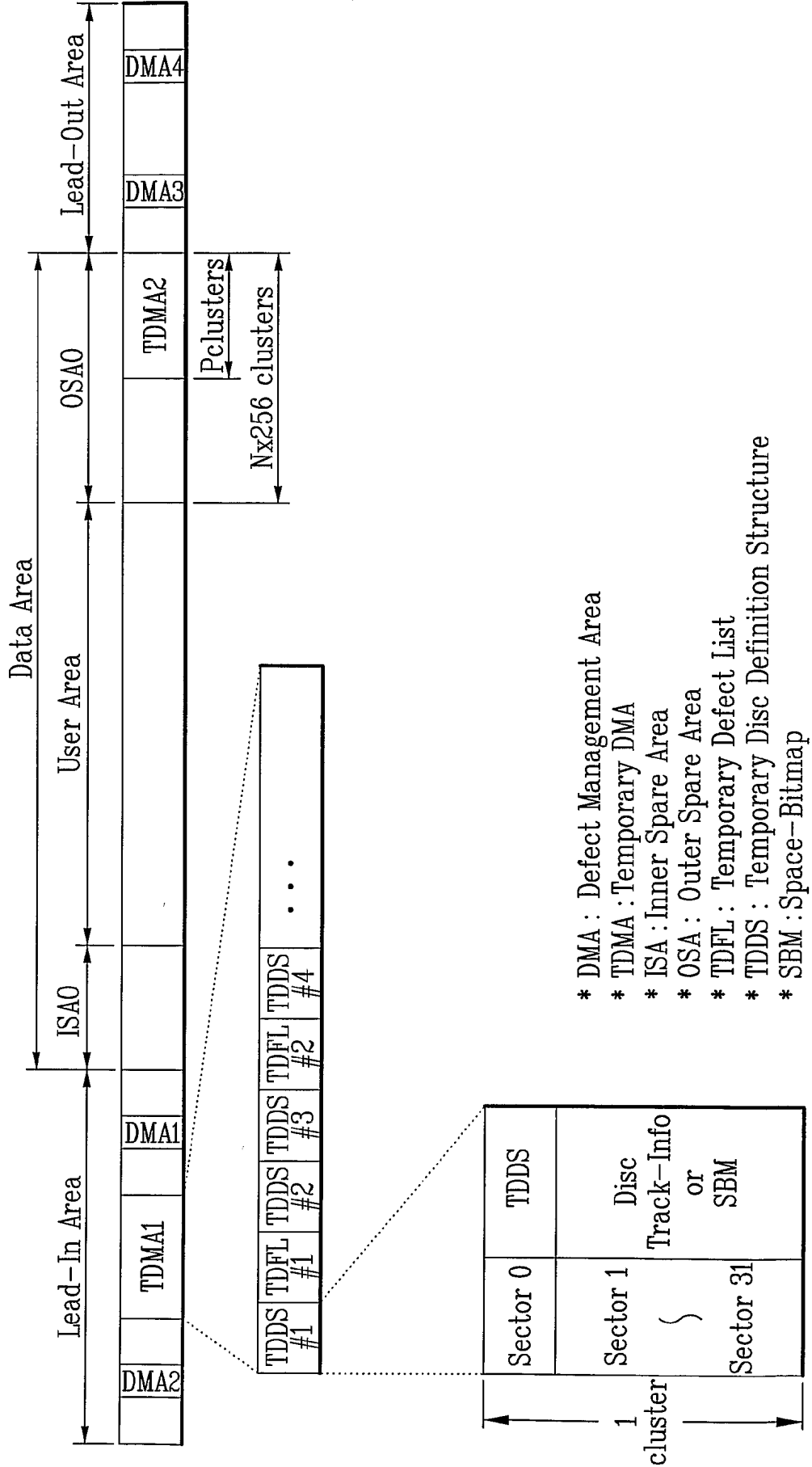

- \* DMA : Defect Management Area
- \* TDMA : Temporary DMA
- \* ISA : Inner Spare Area
- \* OSA : Outer Spare Area
- \* TDFL : Temporary Defect List
- \* TDD# : Temporary Disc Definition Structure
- \* SBM : Space-Bitmap

FIG. 2

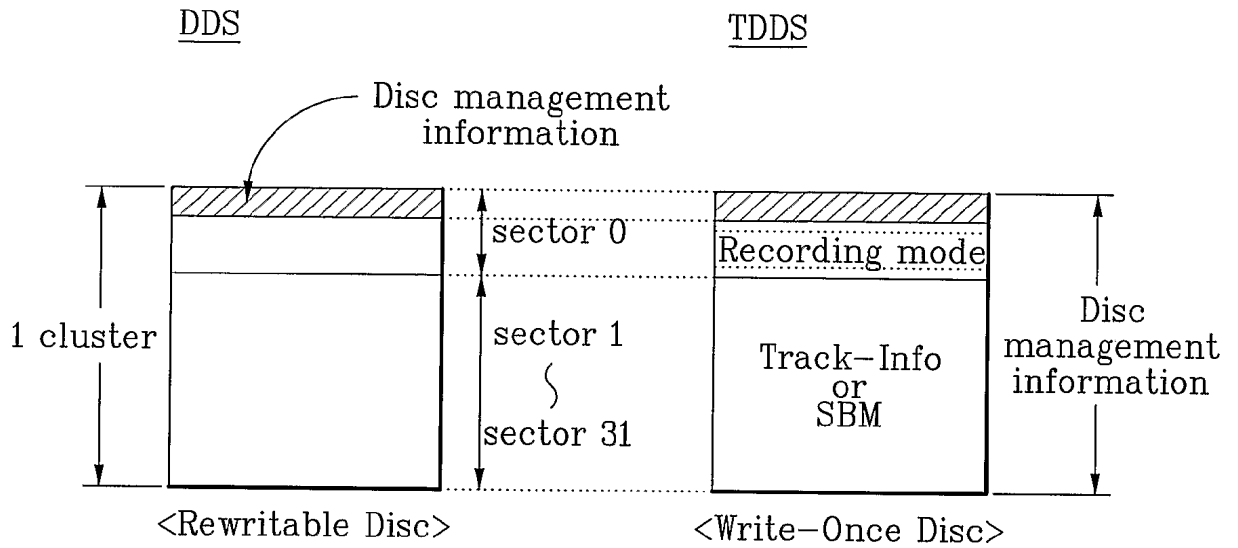

- \* Recording mode
  - 0000 0000b : Sequential Recording
  - 0000 0001b : Random Recording

FIG. 3

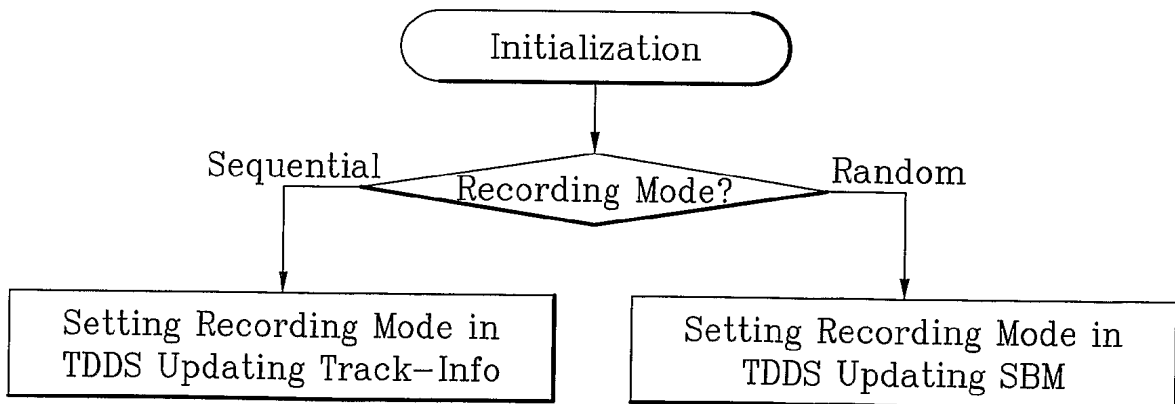
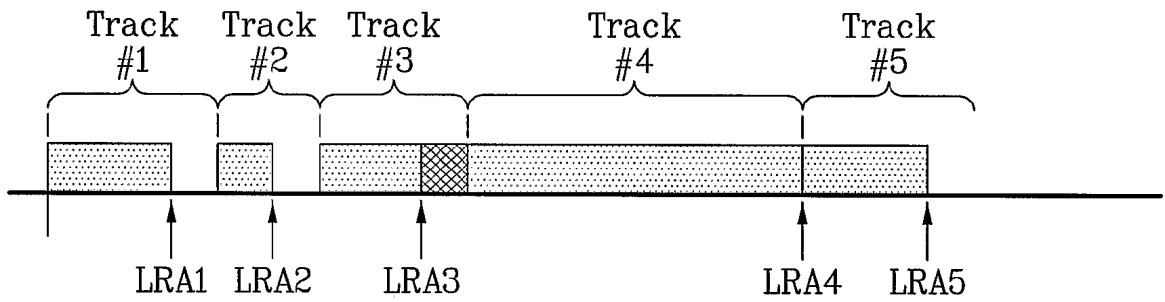

FIG. 4



\*LRA : Last Recorded Address

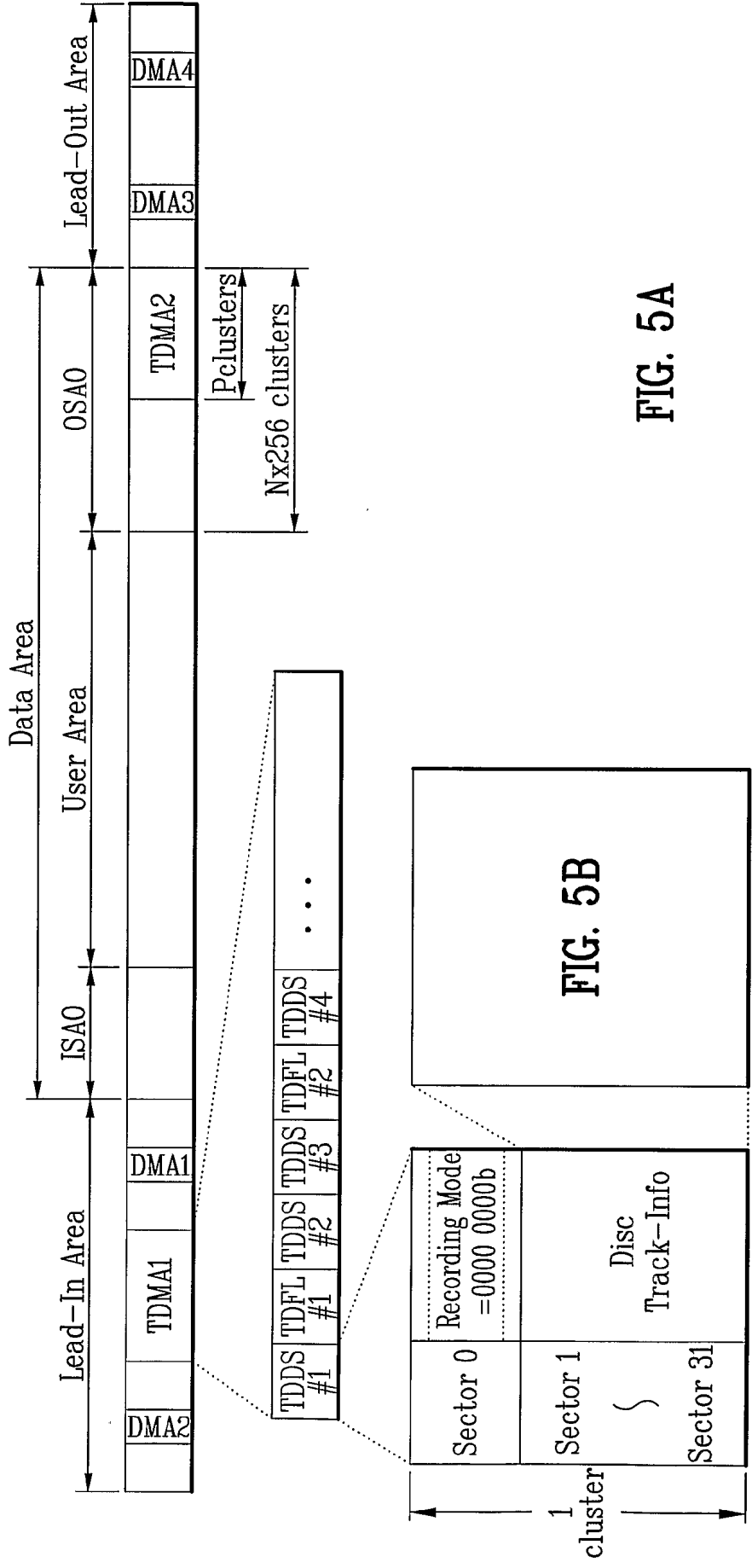

FIG. 5A

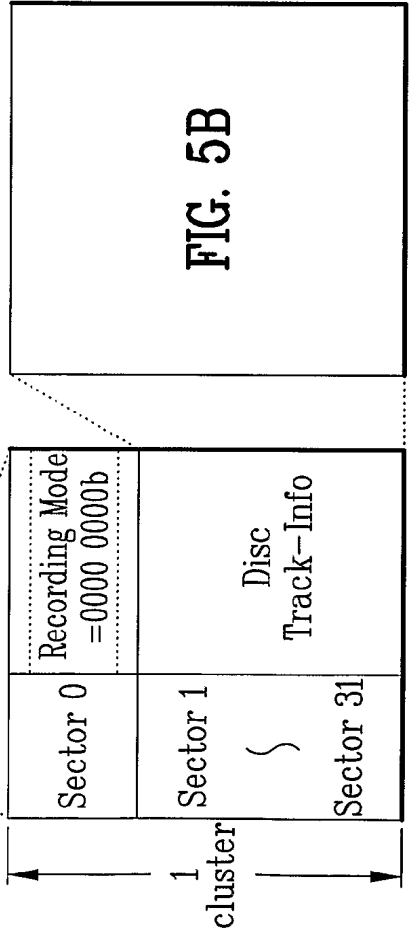

FIG. 5B

\* Sequential Recording Mode

- \* DMA : Defect Management Area
- \* TDMA : Temporary DMA
- \* ISA : Inner Spare Area
- \* OSA : Outer Spare Area
- \* TDFL : Temporary Defect List
- \* TDDS : Temporary Disc Definition Structure

FIG. 5B

Byte position in Data Frame	Contents	number of bytes
0	Track Info Structure identifier	2
2	Track Info format = 00h	1
3	reserved and set to 00h	1
4	Layer number (0 or 1)	4
8	Total number of tracks	4
12	Total number of open tracks	4
16	List of Track Info	n * 8
n * 8	Track Info List Terminator	
	Reserved and set to 00h	

b63 .. b60	b59 .. b32	b31 .. b28	b27 .. b0
Track status	Start PSN of Track #n	reserved	LRA of Track #n
Track status	Start PSN of Track #n+1	reserved	LRA of Track #n+1
Track status	Start PSN of Track #n+2	reserved	LRA of Track #n+2
:	:	:	:
:	:	:	:

Track Status

- 0000b : Open Track
- 1000b : Complete Track
- 0001b : Intermediate Track

FIG. 6

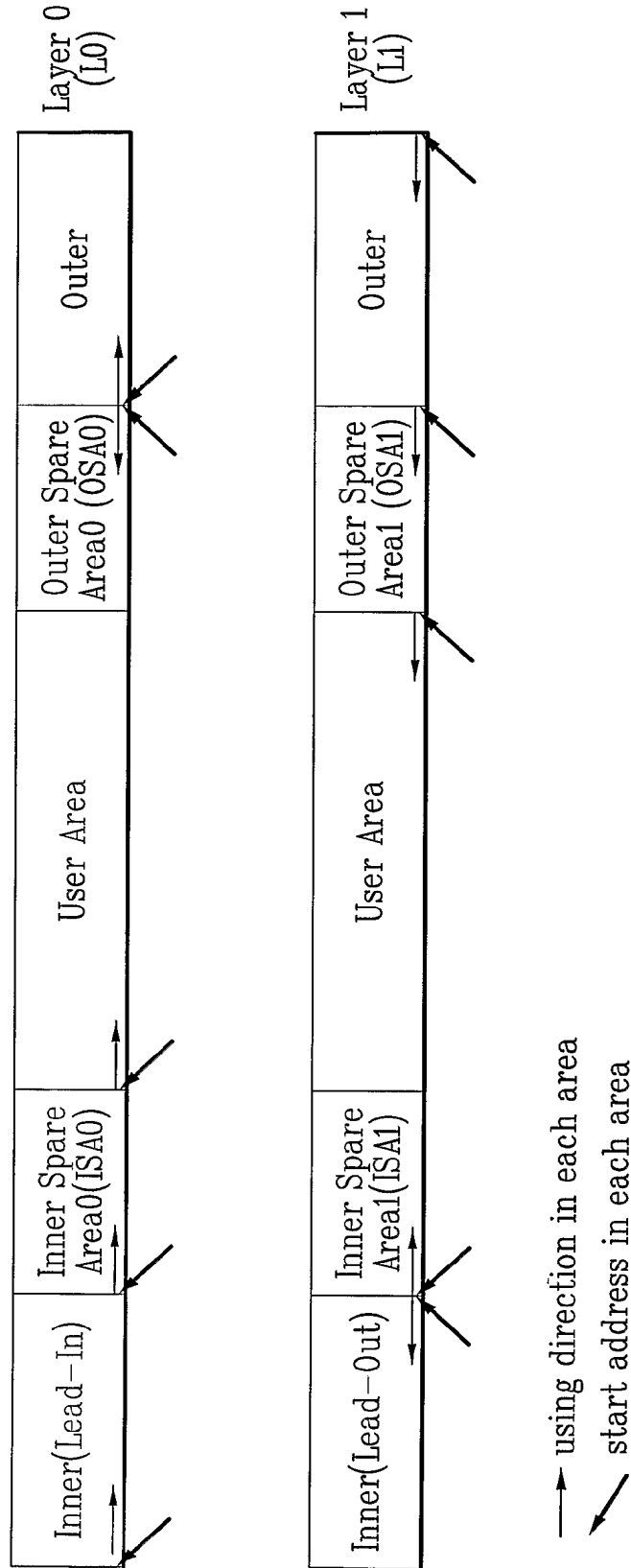



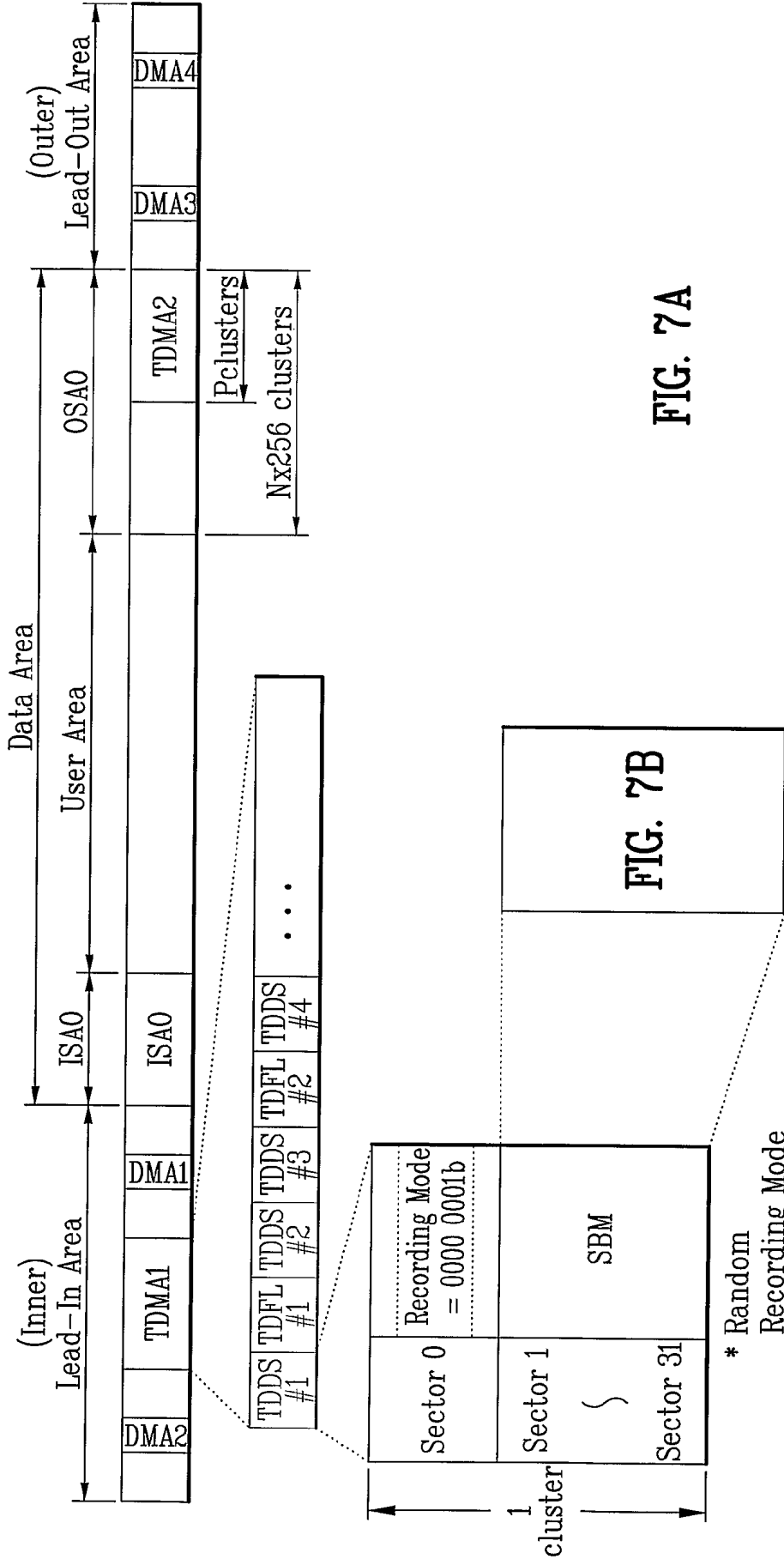

FIG. 7A

FIG. 7B

\* Random Recording Mode

- \* DMA : Defect Management Area
- \* TDMA : Temporary DMA
- \* ISA : Inner Spare Area
- \* OSA : Outer Spare Area
- \* TDFL : Temporary Defect List
- \* TDDS : Temporary Disc Definition Structure
- \* SBM : Space-Bitmap

FIG. 7B

	contents	Number of Bytes
SBM Header	Un-allocated Space Bitmap Identifier = "UB"	2
	Format Version = 00h	1
	Reserved, 00h	1
	Layer Number (0 or 1)	4
	Reserved, 00h	R
SBM Info	SBM for inner Area	
	Start Cluster First PSN	4
	Length in inner area	4
	Bitmap Data	M
	Reserved, 00h	4
	SBM for inner spare Area	
	Start Cluster First PSN	4
	Length in inner spare area	4
	Bitmap Data	N
	Reserved, 00h	4
	SBM for User Area	
	Start Cluster First PSN	4
	Length in user area	4
	Bitmap Data	0
	Reserved, 00h	4
	SBM for outer spare Area	
	Start Cluster First PSN	4
	Length in outer spare area	4
	Bitmap Data	P
	Reserved, 00h	4
SBM for Outer Area		
Start Cluster First PSN	4	
Length in outer area	4	
Bitmap Data	Q	
Reserved, 00h	4	
SBM Terminator		

FIG. 8

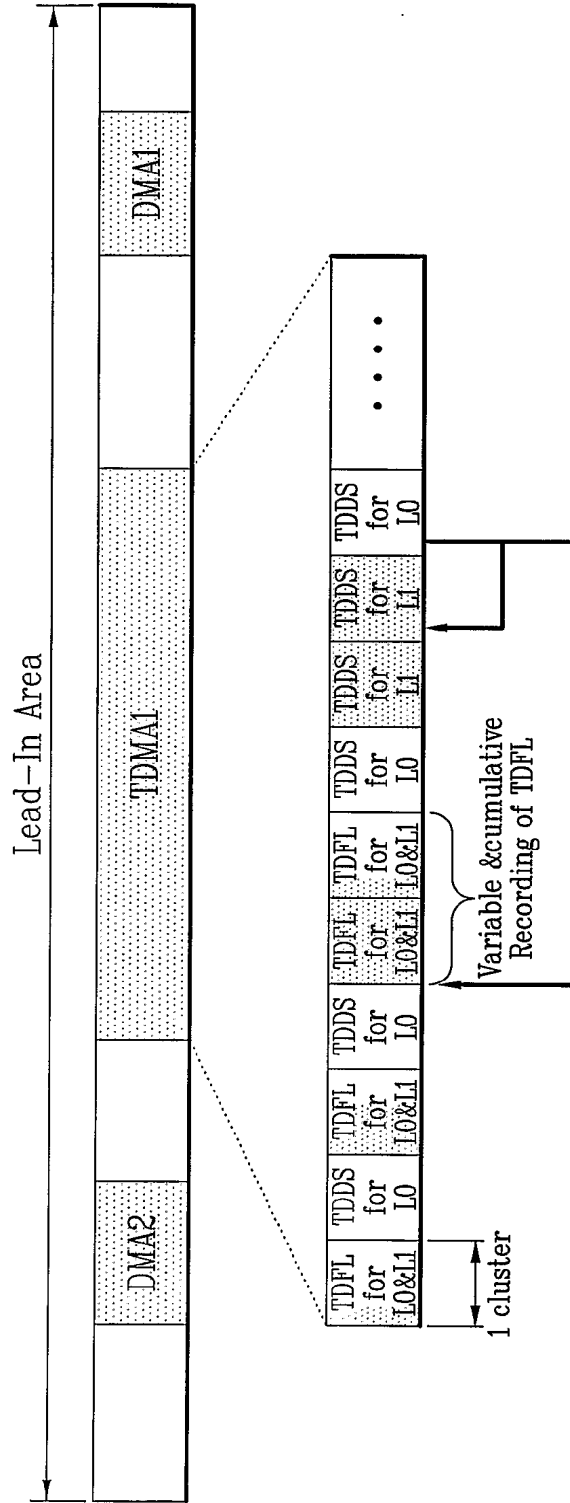

- TDDS for L0 has a pointer to the latest TDFL for L0 & L1, and
- TDDS for L1 has a pointer to the latest TDFL for L0 & L1
- TDDS for L0 and TDDS for L1 have a pointer to each other
- The latest TDDS shall point to the latest TDFL



FIG. 10

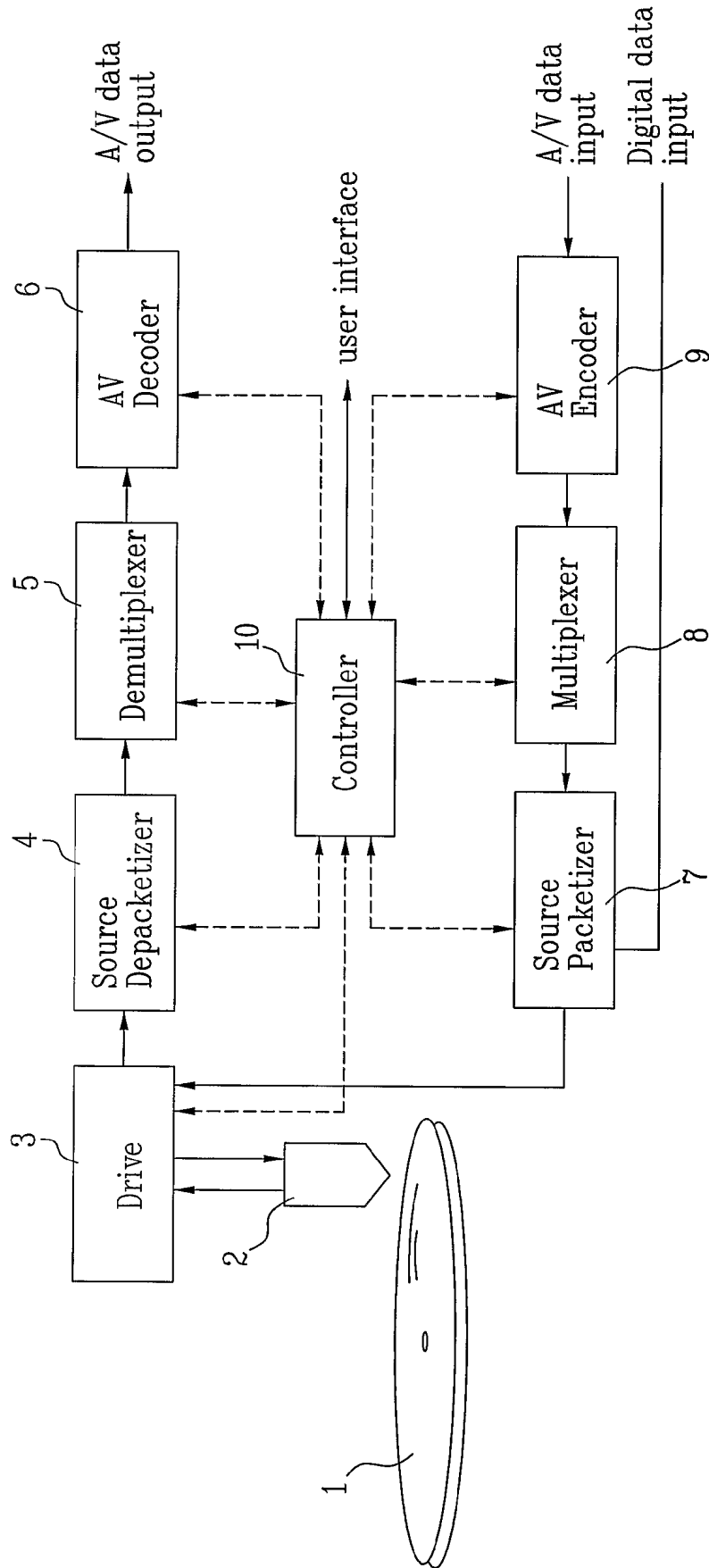

## INTERNATIONAL SEARCH REPORT

International application No.  
PCT/KR 2004/001057

A. CLASSIFICATION OF SUBJECT MATTER <b>G11B 20/10</b> According to International Patent Classification (IPC) or to both national classification and IPC		
B. FIELDS SEARCHED		
Minimum documentation searched (classification system followed by classification symbols) <b>G11B 20/10, 20/12</b>		
Documentation searched other than minimum documentation to the extent that such documents are included in the fields searched <b>G06F 12/14, 12/16</b>		
Electronic data base consulted during the international search (name of data base and, where practicable, search terms used) <b>WPI</b>		
C. DOCUMENTS CONSIDERED TO BE RELEVANT		
Category*	Citation of document, with indication, where appropriate, of the relevant passages	Relevant to claim No.
A	US 2002136118 A1 (TAKAHASHI) 26 September 2002 (26.09.2002)	1,22,26,29,35- 37,40-42
	--	
A	EP 464811 A (MATSUHSITA) 8 January 1992 (08.01.1992)	1,22,26,29,35- 37,40-42
	----	
<input type="checkbox"/> Further documents are listed in the continuation of Box C. <input checked="" type="checkbox"/> See patent family annex.		
* Special categories of cited documents: "A" document defining the general state of the art which is not considered to be of particular relevance "E" earlier application or patent but published on or after the international filing date "L" document which may throw doubts on priority claim(s) or which is cited to establish the publication date of another citation or other special reason (as specified) "O" document referring to an oral disclosure, use, exhibition or other means "P" document published prior to the international filing date but later than the priority date claimed "T" later document published after the international filing date or priority date and not in conflict with the application but cited to understand the principle or theory underlying the invention "X" document of particular relevance; the claimed invention cannot be considered novel or cannot be considered to involve an inventive step when the document is taken alone "Y" document of particular relevance; the claimed invention cannot be considered to involve an inventive step when the document is combined with one or more other such documents, such combination being obvious to a person skilled in the art "&" document member of the same patent family		
Date of the actual completion of the international search 12 July 2004 (12.07.2004)		Date of mailing of the international search report 6 September 2004 (06.09.2004)
Name and mailing address of the ISA/ AT <b>Austrian Patent Office</b> Dresdner Straße 87, A-1200 Vienna Facsimile No. +43 / 1 / 534 24 / 535		Authorized officer <b>GRÖSSING G.</b> Telephone No. +43 / 1 / 534 24 / 386

# INTERNATIONAL SEARCH REPORT

Information on patent family members

International application No.  
PCT/KR 2004/001057

Patent document cited in search report	Publication date	Patent family member(s)	Publication date
EP A 464811		DE T 69127776T	1998-03-19
		DE D 69127776D	1997-11-06
		US A 5270877	1993-12-14
		EP A 0464811	1992-01-08
		JP A 4067471	1992-03-03